

**PARD**



**USA**  
**User Manual**

**Digital Night Vision Camera**  
**NV009 Series**

## Scan To Enjoy Privilege



**Scan The QR Code to Join Our Membership**

- 1 Extend warranty
- 2 Enjoy 1 on 1 expert service
- 3 Get the product experience officer opportunity

# CONTENTS



1. INTRODUCTION .....	02
2. PRECAUTIONS .....	02
3. PACKAGE CONTENTS .....	03
4. DESCRIPTION & KEY FEATURES .....	04
5. SPECIFICATIONS .....	05
6. COMPONENTS .....	07
7. INSTALLATION .....	09
8. OPERATION INSTRUCTION .....	13
8.1 Interface .....	13
8.2 Shortcut Mode .....	14
8.3 Functions .....	18
9. FCC WARNING .....	25

## INTRODUCTION

Thank you for choosing the PARD NV009 handheld monocular digital night vision series. Please read this manual carefully before using the device to ensure proper and safe operation. Please keep this manual in a safe place for future reference. It provides step-by-step instructions for using your night vision scope.











This manual is for reference purposes only and may be subject to updates without prior notice. For the latest information, please visit PARD's official website. PARD reserves the final right to interpret this manual.

## PRECAUTIONS

- **Battery Usage:** Please remove the insulating tape from the battery before first use. Use a fully charged lithium-ion battery with a voltage rating of 3.7V.
- **Device Storage:** Turn off the device and remove the battery if not use for more than 10 days. Store the device & battery in a dry and safe place.
- **Handling and Transportation:** Exercise caution when handling or transportation the device. It is recommended to use the original packaging for transportation.
- **Light Exposure:** Do not use the device to focus directly on strong sources of light such as the sun or electric welding. Direct exposure may damage the detector and void the warranty.
- **Lens Protection:** Prevent lens scratches and damage from oil or chemical contamination. Keep the lens cap on when not in use.
- **Environmental Considerations:** Place the device in a cool, dry, and well-ventilated environment. Avoid strong electromagnetic fields. Ensure the storage temperature remains between  $-20^{\circ}\text{C}/-4^{\circ}\text{F}$  and  $50^{\circ}\text{C}/122^{\circ}\text{F}$ .
- **Device Disassembly and Support:** Please refrain from attempting to disassemble the device without proper authorization. Unauthorized disassembly can result in voiding the warranty and may cause irreparable damage to the device. If you encounter any problems, please contact our after-sales team. Report any issues promptly to ensure timely resolution and proper support.

- **Attention! Export Requirements:** Please note that all PARD night-vision and thermal imaging devices require a license for export outside the country.

## PACKAGE CONTENTS

Icons	Contents	Quantity
	NV009 Unit	1
	3.7V 18650 Rechargeable Lithium-Ion battery	1
	Hand strap	1
	Type-C cable	1
	Shoulder belt	1
	Cloth bag	1
	Lens cap	1
	Oxford cloth bag	1
	User's manual	1
	After-sales card	1

## DESCRIPTION & KEY FEATURES

Introducing the NV009, a highly precise, compact and lightweight digital night vision monocular, designed to be your ultimate tool for accurate wildlife spotting. Its low-illumination and high-sensitivity sensor ensure a clearer view of your targets. With its rugged and IP67-rated design, this device becomes a reliable outdoor companion, well-prepared to face any outdoor challenge, enabling you to move freely even in windy and rainy conditions.

Equipped with a rechargeable 18650 lithium battery, the NV009 is easy to carry, and its large capacity saves you the trouble of frequent battery replacements. Its user-friendly operation enables you to focus on exploring the mysteries of the night. Whether observing animals, camping, or hunting, the NV009 empowers you to fearlessly embrace the darkness and enjoy a unique nocturnal outdoor experience.

### Key features

- CMOS Image Sensor
- Compact and lightweight, weighing only 306g with battery
- Visible Light Enhancement Algorithm (VLEA)
- Adjustable beam IR illuminator with a range of 200m
- Capture photos and videos to record exciting moments during outdoor activities
- WiFi
- IP67 Rating

## SPECIFICATIONS

<b>Model</b>	<b>NV009</b>		
<b>Classification</b>	Digital Night Vision (Monocular)		
<b>Sensor(CMOS)</b>			
<b>Resolution(pixel)</b>	1920*1080	<b>Sensitivity(lux)</b>	0.001
<b>Pixel size(μm)</b>	2.9	<b>Frame rate(Hz)</b>	60/30
<b>Optics</b>			
<b>Objective lens(mm)</b>	25	<b>Optical magnification(x)</b>	4.7
<b>Digital zoom(x)</b>	1.5-3.0	<b>Continuous digital zoom(x)</b>	7-14
<b>Focus range(m)</b>	3m - ∞	<b>Eye relief(mm)</b>	25
<b>Exit pupil(mm)</b>	6	<b>Diopter adjustment(D)</b>	± 5
<b>Field of view(HxV)</b>	Horizontal	9.1°	
	Vertical	5.1°	
	Diagonal	10.4°	
<b>IR Illuminator</b>			
<b>IR type</b>	VCSEL	<b>IR illuminating level</b>	3 Levels
<b>IR power(W)</b>	5	<b>IR wavelength(nm)</b>	850/940
<b>Display(OLED)</b>			
<b>Resolution(pixel)</b>	1024*768	<b>Color mode</b>	Color/Black&White

Photo/Video			
<b>Photo resolution(pixel)</b>	2592*1944	<b>Photo format</b>	.JPG
<b>Video resolution(pixel)</b>	1920*1080	<b>Video format</b>	.mp4
Main functions			
<b>PIP</b>	yes	<b>E-compass</b>	yes
<b>Auto recording</b>	yes	<b>Loop recording</b>	yes
<b>Time stamp</b>	yes	<b>Record audio</b>	yes
<b>Beep sound</b>	yes	<b>Exposure</b>	yes
<b>USB Type-C</b>	yes	<b>WiFi</b>	yes
<b>HDMI output</b>	yes	<b>Supported apps</b>	PardVision
<b>Operating time (h, max.)</b>	≤8	<b>Output voltage(V)</b>	3.7
<b>Housing</b>	AL6061 & Composite	<b>Objective lens</b>	Glass



# COMPONENTS

NV009

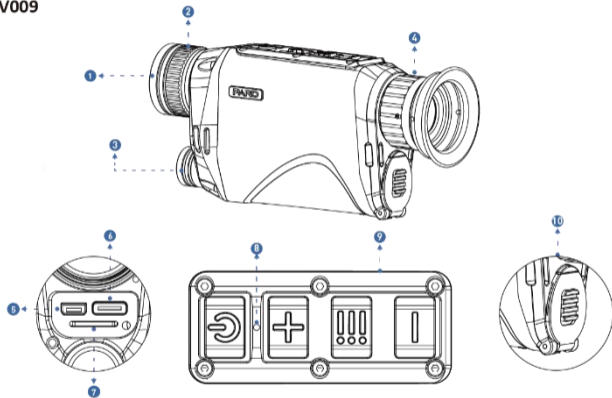

Fig. 1

No.	Name	No.	Name
①	Objective lens	⑥	Micro SD card slot
②	Objective lens focus ring	⑦	Type-C charging port
③	Adjustable beam IR illuminator	⑧	Power indicator
④	Eyepiece focus ring	⑨	Keypad
⑤	HDMI port	⑩	Battery compartment cap

## Keypad

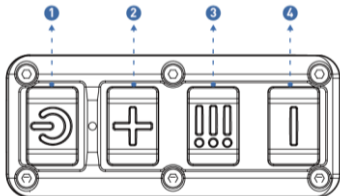

Fig. 2

Keypad No.	Functions
①	Power/Sleep button
②	Zoom(+)/Disable WiFi/Play Back
③	Recording/OK/Menu
④	IR/Mode Switch/(-)

# INSTALLATION

## 1. Unboxing

Before using this device, please follow these steps:

- 1 Open the box and carefully remove the device.
- 2 Verify that all items listed in the package contents are included in the box.
- 3 Inspect the device for any signs of damage to the display, body, lens, buttons, and other components.
- 4 Ensure that the objective lens and eyepiece are clean and in proper working condition.

**Note:** If you find any accessories missing or damaged, please contact our after-sales service for assistance.

## 2. Battery Installation and Startup

Please following the steps below for battery installation:

- (1) Press and hold down on the battery compartment cap until it open. Then take out the battery as shown in Fig. 3;
- (2) Remove the insulating tape from the battery.

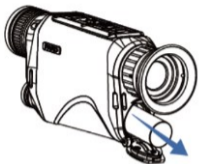

Fig. 3

- (3) Insert the battery with the positive terminal facing inward, then press down on the battery cover until it locks into place (Fig. 5);

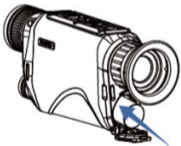

Fig. 5



Fig. 4

- (4) To power on the device, press and hold the power button for approximately 3 seconds. The device is ready for use when the power indicator illuminates and the PARAD Logo appears on the screen (Fig. 6);



Fig. 6

**Note:**

- ① Use a single 18650 rechargeable lithium-ion battery with a voltage rating 3.7V;
- ② Do not expose the battery pack to high temperature or to a naked flame.

- 3 Do not put the device into water when the battery cover is open;
- 4 Do not expose disassemble the device without authorization;
- 5 Do not pierce the device with sharp objects;
- 6 Battery should be kept out of reach of children, and the positive and negative terminals of the battery should be installed correctly;
- 7 Whilst charging the battery do not leave the battery unattended.
- 8 When using the battery at cold(low) temperatures, the battery capacity decreases, this is normal and not a defect.
- 9 Do not use the battery if it has been damaged in any way.
- 10 After charging is complete do not leave the battery on charge connected to the network.



Please act responsibly and recycle or dispose of all used batteries according to the law.

### 3. Focusing

#### Diopter Adjustment Ring

Diopter adjustment in a night vision device refers to the ability to adjust the focus of the device's eyepiece to compensate for differences in users' vision. It allows individuals with varying levels of eyesight to achieve a clear and focused view of the displayed content on the device's screen.

- 1 After turning on the device, rotate the diopter adjustment ring until the texts or icons on the screen are clearly.
- 2 Please note that the image may not be clear after diopter adjustment. As long as the text on the screen is clear and visible, it is sufficient.

**Note:** If the objective lens is not properly focused, the image may be unclear.

### Objective Lens Adjustment Ring

- 1 Before adjusting the objective lens, it is important to complete the diopter focusing.
- 2 Then adjust the objective lens focus ring until a clear image of the target is achieved.

## 4. E-compass Calibration

Once the eyepiece is properly focused, proceed to calibrate the electronic compass using the "Figure 8" pattern method. Tilt and move the device in a Figure 8 motion until the compass is calibrated, as indicated in **Fig. 7**.



**Fig. 7**

## OPERATION INSTRUCTION

### Interface

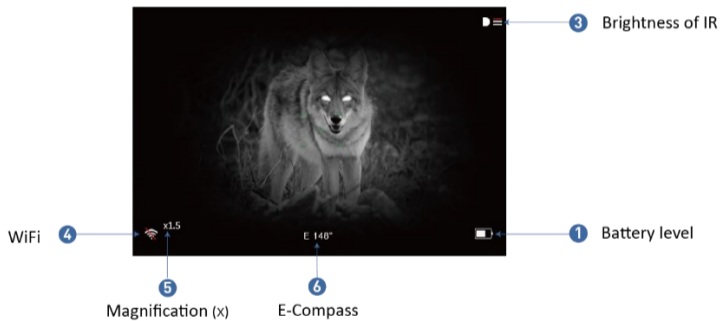

Fig. 8

## Shortcut Mode

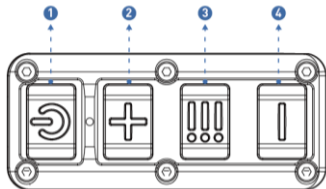

Fig. 9

Keypad	Single press	Press and hold	Double press
①	(Powered on)Sleep/Wakeup	Power on/off	-
②	Zoom/(+)/Browse video files	Enter video files/Disable WiFi	Open/Close PIP
③	OK/Menu	Recording/Play back	Take photo
④	Brightness of IR(Black&White mode)/(-)	Switch between black&white/color mode	-



## Explanation:

### Key 1(Power key):

#### 1. Single press:

Click it to enter sleep mode, and click again to exit sleep mode;

#### 2. Press and hold:

Press and hold the power button for 3 seconds to power on/off the device;

### Key 2:

#### 1. Single press:

① **Home screen mode:** click to zoom in for magnification, with zoom levels in the following sequence: x1.5 / x2.0 / x2.5 / x3.0;

② **Menu mode:** single press it to increases value or navigate forward through options;

#### 2. Press and hold:

① When the WiFi function is turned off, press and hold [key 2] to access the video files interface;

a) In the video files interface, press [Key 2] or [Key 4] to switch the video file;

b) Press [Key 3] to play or pause the video;

c) While playing the video, pressing [Key 2] or [Key 4] will allow you to fast forward or rewind at 2x, 4x, or 8x speed;

d) In the video file interface, single press [Key 3] to access the following settings;

1)Delete: <ul style="list-style-type: none"> <li>● Delete Current</li> <li>● Delete All</li> </ul>	2)Protect: <ul style="list-style-type: none"> <li>● Lock Current</li> <li>● Unlock Current</li> <li>● Lock All</li> <li>● Unlock All</li> </ul>	3)Slide Show: <ul style="list-style-type: none"> <li>● 2 seconds</li> <li>● 5 seconds</li> <li>● 8 seconds</li> </ul>
---	--	--

e) Press and hold [Key 3] to exit the above settings and return to the video file interface;

f) Then, press and hold [Key 2] to exit the video files interface and return to the home screen.

② When the WiFi function is enabled, press and hold [Key 2] to disable the WiFi function.

### 3. Double press:

**Home screen mode:** double press [Key 2] to toggle the PIP function on/off;

## Key 3:

### 1. Single press:

① **Home screen mode:** press [Key 3] to enter the menu, press and hold [Key 3] to exit the menu;

② **In the menu mode:** press [Key 3] to confirm the selection;

### 2. Press and hold:

**Home screen mode:** press and hold [Key 3] to start video recording (with SD card inserted), and long press [key 3] again to stop video recording;

### 3. Double press:

**Home screen mode:** double press [Key 3] to take photo (with Micro SD card inserted);

## Key 4:

### 1. Single press:

In Black&White mode, with the IR illuminator turned on, press [Key 4] to adjust the brightness level of the IR illuminator. Each press will cycle through the following options: Off - 1 Level - 2 Level - 3 Level - Off.

### 2. Press and hold:

**Home screen mode:** press and hold [Key 4] to toggle between Black&White and Color mode.

## Functions

**Home screen mode:** press [key 3] to enter the menu mode, where you can set various function options within the menu bar. Please note that the shortcut key function is disabled in this mode.



**Fig. 10**

## 1. Center Marking

This function allows you to select the option of enabling the center marking during observation.

- Press [Key 4] to the Center Marking option. Press [Key 3] to enter the sub-menu interface;
- Press [Key 2]/[Key 4] to select "Off" or "On" options, and then press [Key 3] to save and return to the previous page;

## 2. PIP

The top center of the display can show a 2x magnified picture for enhanced aiming visibility. This allows you to see magnified target details without sacrificing the field of view.

- Press [Key 2]/[Key 4] to the date stamp option. Press [Key 3] to enter the sub-menu;
- Press [Key 2]/[Key 4] to select "Off" or "On" options;
- and then press [Key 3] to save and return to the previous page;

## 3. Default Color

This function allows you to select the default color mode for the night vision spectrum of this device. There are two options available: color and black&white mode.

- Press [Key 2]/[Key 4] to the default color option. Press [Key 3] to enter the sub-menu interface;
- Select the desired default color, click [Key 2] to save and return to the menu.

## 4. Brightness of IR

This function allows you to adjust the brightness of IR illuminator.

- Press [Key 2]/[Key 4] to the brightness of IR option. Press [Key 3] to enter the sub-menu interface;

- Press [Key 2]/[Key 4] to select among "Off", "1", "2", "3" option and then press [Key 3] to save and return to the previous page.

## 5. Display Brightness

This function allows you to adjust the brightness of the screen.

- Press [Key 2]/[Key 4] to the display brightness option. Press [Key 3] to enter the sub-menu interface.
- Select "0", "Level 1", "Level 2", "Level 3", "Level 4", "Level 5", or "Level 6" by pressing [Key 2]/[Key 4].

## 6. Auto recording

Once this function is enabled, the device will initiate automatic recording and continue this operation after the next power-on.

- Press [Key 2]/[Key 4] to the auto recording option. Press [Key 3] to enter the sub-menu.
- Press [Key 2]/[Key 4] to select "Off" or "On" options, and then press [Key 3] to save and return to the previous page.

## 7. Loop recording

Users can customize the segment recording duration by accessing the loop recording settings. When the memory card reaches its full capacity, new recordings will automatically overwrite the previously saved files. Selecting "Off" will stop recording when the memory card is full, and the oldest video file will not be overwritten.

- Press [Key 2]/[Key 4] to the loop recording option. Press [Key 3] to enter the sub-menu.
- Press [Key 1]/[Key 3] to select "Off", "3 Min", "5 Min" or "10 Min" and then press [Key 2] to save and return to the previous page.

## 8. Date Stamp

Users can customize the display of a time stamp in the lower right corner of captured photos and videos.

- Press [Key 2]/[Key 4] to the date stamp option. Press [Key 3] to enter the sub-menu;
- Press [Key 2]/[Key 4] to select "Off" or "On" options, and then press [Key 3] to save and return to the previous page.

## 9. Record Audio

User can choose whether to record audio along with the video.

- Press [Key 2]/[Key 4] to the record audio option. Press [Key 3] to enter the sub-menu;
- Press [Key 2]/[Key 4] to select "Off" or "On" options, and then press [Key 3] to save and return to the previous page;

## 10. Beep Sound

With this feature, you can enable or disable the key sound while navigating menu options when an external HDMI device is connected.

- Press [Key 2]/[Key 4] to the beep sound option. Press [Key 3] to enter the sub-menu interface.
- Press [Key 2]/[Key 4] to select "Off" or "On" options, and then press [Key 3] to save and return to the previous page.

## 11. WiFi

Through the WiFi connection, you can use your phone, PC or tablet as an external viewfinder enabling users to synchronously see the photos and videos on a larger screen.

- Press [Key 2]/[Key 4] to the WiFi option. Press [Key 3] to enter the sub-menu;

- Press [Key 2]/[Key 4] to select "Off" or "On" options. Choose "Off" and press [Key 2] to save and go back to the previous page. Select "On" to enable Wi-Fi and return to the home screen.

**Steps to connect to your mobile device:**

- Download "PardVision" from the Apple App Store or the Google Play Store.
- Enable Wi-Fi on both your device and your mobile device.
- Search for the Wi-Fi network on your mobile device (the device Wi-Fi network is a string of characters starting with PARD, which is a unique string of numbers). Please enter the password: 12345678 to connect.
- Enter the application to operate and use.

**Note:** After enabling Wi-Fi, you cannot access the menu. Press and hold [Key 4] to disable the Wi-Fi and then enter the menu interface.

## 12. Exposure

Users can choose their preferred exposure settings.

- Press [Key 2]/[Key 4] to the exposure option. Press [Key 3] to enter the sub-menu;
- Use [Key 2]/[Key 4] to select your preferred option, and then press [Key 3] to save and return to the previous page.

## 13. Language:

Users can choose their preferred language.

- Press [Key 2]/[Key 4] to the date stamp option. Press [Key 3] to enter the sub-menu;
- Press [Key 2]/[Key 4] to your preferred language and then press [Key 3] to save and return to the previous page.



## 14. Date/Time

Users can set the system date and time of the device.

- Press [Key 2]/[Key 4] to the date stamp option. Press [Key 3] to enter the sub-menu;
- Press [Key 2]/[Key 4] to adjust the date and time value, and then press [Key 3] to switch options. Press [Key 3] to save and return to the previous page.

## 15. Format

Please note that reformatting the TF Card will permanently delete all data, and it cannot be recovered. Please operate with caution!

- Press [Key 2]/[Key 4] to the date stamp option. Press [Key 3] to enter the sub-menu;
- Press [Key 2]/[Key 4] to select "Cancel" or "OK" option. After selection, press [Key 3] to confirm the relevant operation and return to the previous page.

## 16. Default Setting

Resetting the device will restore it to the factory default settings, deleting all user data and personalized settings. Proceed with caution when performing this operation!

- Press [Key 2]/[Key 4] to the date stamp option. Press [Key 3] to enter the sub-menu;
- Press [Key 2]/[Key 4] to select "Cancel" or "OK" option. After selection, press [Key 3] to confirm the relevant operation and return to the previous page.

## 17. Version

This function displays the device's version.

- Press [Key 2]/[Key 4] to the version option. Press [Key 3] to enter the sub-menu;
- Press [Key 3] again to return to the previous page.

## FCC WARNING



This device complies with part 15 of the FCC Rules. Operation is subject to the following two conditions:

- (1) This device may not cause harmful interference, and
- (2) this device must accept any interference received, including interference that may cause undesired operation.

**Note:** This equipment has been tested and found to comply with the limits for a Class B digital device, pursuant to part 15 of the FCC Rules. These limits are designed to provide reasonable protection against harmful interference in a residential installation. This equipment generates, uses and can radiate radio frequency energy and, if not installed and used in accordance with the instructions, may cause harmful interference to radio communications. However, there is no guarantee that interference will not occur in a particular installation. If this equipment does cause harmful interference to radio or television reception, which can be determined by turning the equipment off and on, the user is encouraged to try to correct the interference by one or more of the following measures:

- Reorient or relocate the receiving antenna.
- Increase the separation between the equipment and receiver.
- Connect the equipment into an outlet on a circuit different from that to which the receiver is connected.
- Consult the dealer or an experienced radio/TV technician for help.

**Note:** The Grantee is not responsible for any changes or modifications not expressly approved by the party responsible for compliance. Such modifications could void the user's authority to operate the equipment. The device has been evaluated to meet general RF exposure requirements. This equipment complies with FCC's RF radiation exposure limits set forth for an uncontrolled environment. This device and its antenna(s) must not be co-located or in conjunction with any other antenna or transmitter.

# Follow Us



Facebook



Instagram



YouTube



LinkedIn



YouTube



Website



[www.pard.com](http://www.pard.com)

Business Cooperation



[info@pard.com](mailto:info@pard.com)

Service Center



[support@pard.com](mailto:support@pard.com)

## PARD USA



Optimax Technology LLC

+1 (800) 986 4370

3500 Lakeside Court Suite 200, Reno, NV 89509, US



RoHS